



1983'den bugüne...



- AZZ 42-BF |
- AZZ 57-SRV |
- AZZ M-4257 |
- AZZ 42-CF |
- AZZ 42-CF AUTO FEED |
- AZZ 42-CF AUTO FEED LINE |
- AZZ 42-CF & STACKER |
- AZZ RTR-20 |
- AZZ-PPR |
- AZZ FLW-S1 |



Zarf Tipi Paketlemede
Mükemmellik...



AZZ PPR®

**Kağıt Zarf ve Oyun Kağıdı
Paketleme Makinası**

Paper Envelopes & Playing
Cards Bundling Machine

Tam Otomatik Zarf Tipi Sarmalama Makinaları

Full Automatic Over Wrapping Machinery Production

اوتوماتيكية كاملة في انتاج الات التغليف

www.unlumakinasan.com.tr



CE

AZZ PPR®

Kağıt Zarf ve Oyun Kağıdı Paketleme Makinası

Paper Envelopes & Playing Cards Bundling Machine



AZZ PPR®

Kağıt Zarf ve Oyun Kağıdı Paketleme Makinası
Paper Envelopes & Playing Cards Bundling Machine

İskambil oyun kağıdı, kağıt, zarf ve kağıt demetleri için özel olarak tasarlanmış bir makinedir. Besleme işlemi kağıt paketlemelerinde manuel olarak yapılırken, oyun kağıdı paketlemelerinde ister manuel ister direk üretim hattına full otomatik olarak da yapılabilir.

Makinada, OPP boy ayarı Servo Motor, PLC ve dokunmatik ekran sistemi sayesinde otomatik olarak yapılabilirdiği gibi, tamamen mekanik olarak kolay ve pratik bir şekilde de yapılabilir. Makinada ayrıca istenirse açma bandı aparatı takılarak, paketlenmiş paketlerin kolayca açılması sağlanır ve tarih - seri no yazma cihazıyla da sefonun üstüne tarih ve seri numara atılır.

A special machine for over-wrapping & bundling playing cards, paper envelope reams & any paper reams. Feeding paper reams is done manually while feeding playing cards reams can also be done automatically by a direct inline connection system to the cards stacking machine.

This machine can be supplied with either full automatic OPP length adjustment features via servo motor, PLC & 7.3" touch screen system or mechanical OPP length adjustment & change - over features. Tear Tape applicator and date printer device are available on this machine upon request.

Packet Size Paket Ölçüleri	Min(mm)	Max (mm)
Length - Uzunluk	50	300
Width - Genişlik	40	220
Height - Yükseklik	8	50
OPP Length - Selefon Boyu	115	600
Capacity - Kapasite	20 - 40	
Power - Güç	3.5 KW, 380V - AC 3 Phase	
Weight - Ağırlık	950 kg	

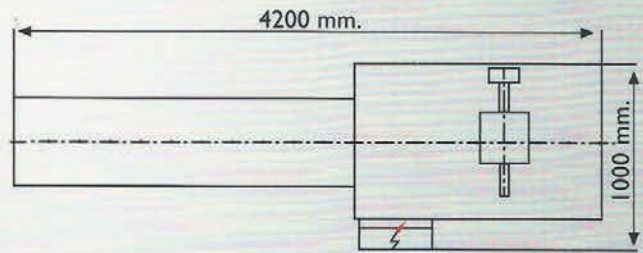

Madenler Durağı Meclis Mahallesi Teraziler Caddesi
PERPİM San. Sit. No:31 A Blok 5 Sancaktepe/İstanbul.TR
Telefon : +90 216 526 05 77 • Fax : +90 216 526 05 76
E-mail : info@unlumakinasan.com.tr

www.unlumakinasan.com.tr



Zarf Tipi Paketlemede
Mükemmellik...
Excellence in
Over - Wrapping



AZZ RTR-20®

Döner Sistem Kutu Ambalajlama Makinası
Rotary System Box Packaging Machine

Döner Sistem Kutu Ambalajlama Makinası
Rotary System Box Packaging Machine
تتميز ماكنتنا هذه بالموصفات التالية؛



www.unlumakinasan.com.tr





AZZ RTR-20®

Döner Sistem Kutu Ambalajlama Makinası

Rotary System Box Packaging Machine

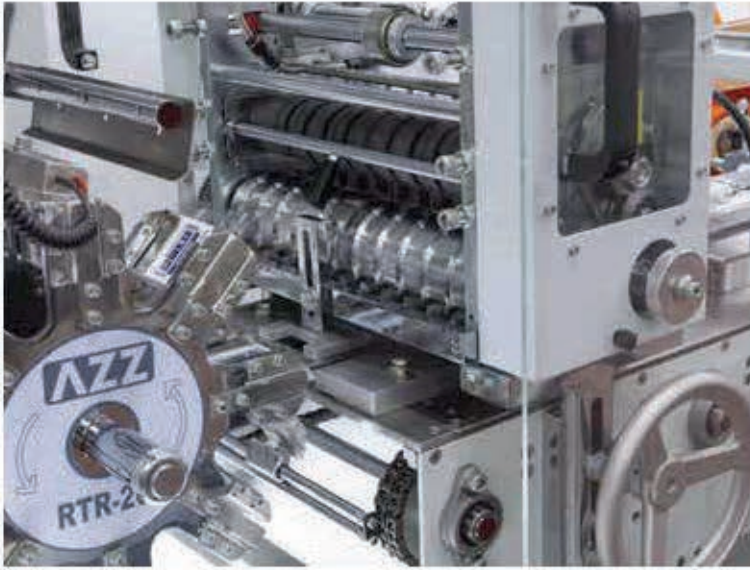

AZZ RTR-20®

Döner Sistem Kutu Ambalajlama Makinası Rotary System Box Packaging Machine

Makinamız, Dikdörtgen şeklindeki küçük hacimli vb. 50 gr Nargile kutusu, Draje sakız ve Şeker kutularını dıřını ambalajlamak için ideal ve hızlı bir makinedir. Makinamızın besleme ünitesinden direk kutulama makinalarına bağlanarak otomatik besleme yapılabilir ve dilerseñiz el ile besleme yapabilirsiniz. Makinamızın Tüm aksanı mekanik olup tek motordan hareket alarak ambalaj boyu kutu itme ve çıkarma işlemleri döner istasyon ile senkron bir şekilde çalışarak kutular ambalaja tek olarak girer ve döner sistemli üç fonksiyonlu istasyonda kontrollü bir şekilde ambalaj olarak tek tek bir birine sürtmeden hızlı bir çıkış yapar ve kutuların mükemmel bir sıklıkla pürüzsüz ambalaj olmasını sağlar.

Açma bandı ünitemiz sistemde standart olup kutulara ambalaj sonrası emniyetli görünüş verip ve kolay açılmasını yardımcı olur.

The machine is an ideal and fast machine for packing the outside of 50 g Hookah box, Draje gum and Sugar boxes with small volume 50 gr etc in the shape of a rectangle. Automatic feeding can be done by connecting directly to the boxing machine from the machine's feeding unit and you can feed manually if you wish. The whole part of the machine is mechanical and the package-length box pushing and removal operations work in sync with the rotary station and the boxes enter the packaging individually and make a quick exit without friction to each other as a controlled package in the three-function station with rotary system and ensure that the boxes are perfectly smooth packaging.

Tear-tape (easy open) unit is standard in the system and gives safe appearance to the boxes after packaging and helps them to be opened easily.

Packet Size Paket Ölçüleri	Min(mm)	(A) Max(mm)
Length - Uzunluk	50	320
Width - Genişlik	40	110
Height - Yükseklik	15	35
OPP Length - Selefon Boyu	110	290
Capacity - Kapasite	20-100	
Power - Güç	3.5 kW, 380V - AC 3Phase	
Weight - Ağırlık	750 kg	

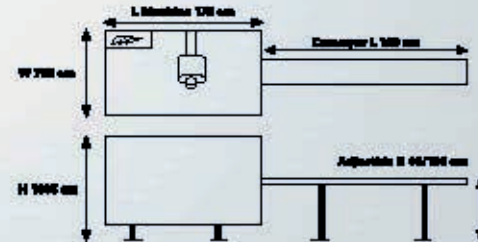
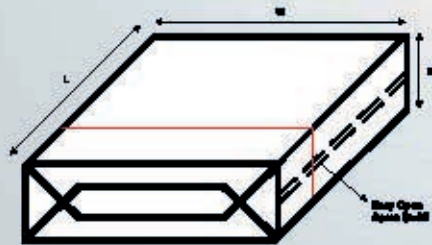

90/216 2130 © 2002 UNLU MAKINA



Madenler Duruđı Meclis Mahallesi Teraziler Caddesi
PERPİM San. Sit. No:31 A Blok 5 Sancaktepe/İstanbul.TR
Telefon : +90 216 526 05 77 • Fax : +90 216 526 05 76
E-mail : info@unlumakinasan.com.tr

www.unlumakinasan.com.tr



Zarf Tipi Paketlemede
Mükemmellik...
Excellence in
Over - Wrapping



AZZ 42 - BF[®]

Klasik Kutu Selefonlama Makinası
Classical Box Over - Wrapping Machine

Tam Otomatik Zarf Tipi Sarmalama Makinaları

Full Automatic Over Wrapping Machinery Production

اوتوماتيكية كاملة في انتاج الات التغليف

www.unlumakinasan.com.tr



CE



AZZ 42 - BF®

Klasik Kutu Selefonlama Makinası Classical Box Over - Wrapping Machine

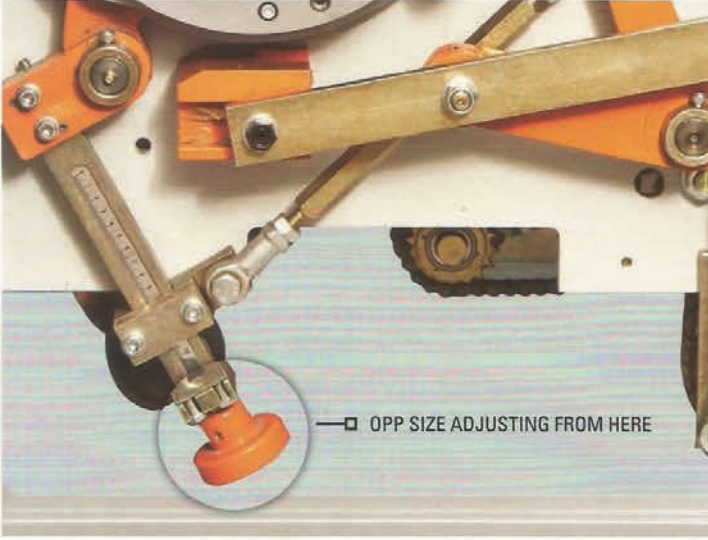

AZZ 42 - BF®

Klasik Kutu Selefonlama Makinası Classical Box Over - Wrapping Machine

Kare ve dikdörtgen şeklindeki küçük ve orta hacimli kutuları tek parça veya sıra halinde sarmalamak için ideal ve kullanışlı bir makinedir. Besleme işlemi manuel olarak yapılabildiği gibi ürünün üretim hattından geliş şekline göre otomatik besleme de yapılabilir.

Makinada, OPP boy ayarı ve diğer kalıp değiştirme ayarları, tamamen mekanik olarak kolay ve pratik bir şekilde yapılmaktadır. Makina ile ayrıca istenirse açma bandı aparatı takılarak, paketlenmiş kutuların kolayca açılması sağlanır ve tarih-seri no yazma cihazıyla da telefonun üstüne tarih ve seri numara atılır.

An ideal machine for over wrapping small & medium size boxes as single box or multi-pack packets. The machine can be feed either manually or automatically with a direct connection to the production line.

AZZ 42 - BF® Machines have mechanical and easy OPP length adjustment & change - over features. Tear tape applicator and date printer device are available on this machine upon request.

Packet Size Paket Ölçüleri	(A)		(B)	
	Min(mm)	Max (mm)	Min(mm)	Max (mm)
Length - Uzunluk	50	320	100	320
Width - Genişlik	35	110	75	225
Height - Yükseklik	10	80	40	80
OPP Length - Selefon Boyu	110	420	250	475
Capacity - Güç	20 - 40			
Power - Güç	3.5 KW, 380V - AC 3 Phase			
Weight - Ağırlık	950 kg			

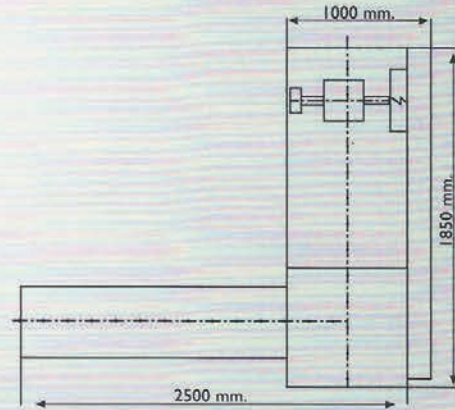
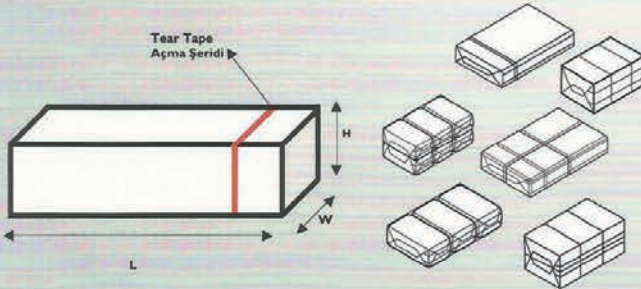

SLIDE-ANAS-2016.03 © 07-2012/09-16



Madenler Duracağı Meclis Mahallesi Teraziler Caddesi
PERPİM San. Sit. No:31 A Blok 5 Sancaktepe/İstanbul.TR
Telefon : +90 216 526 05 77 • Fax : +90 216 526 05 76
E-mail : info@unlumakinasan.com.tr

www.unlumakinasan.com.tr



Zarf Tipi Paketlemede
Mükemmellik...
Excellence in
Over - Wrapping



AZZ 42 - CF[®]

**Sabun, Bisküvi,
Gofret ve Kutu Paketleme Makinası**
Soap, Biscuits, Waffle & Box Bundling Machine



Tam Otomatik Zarf Tipi Sarmalama Makinaları
Full Automatic Over Wrapping Machinery Production

اوتوماتيكية كاملة في انتاج الات التغليف

www.unlumakinasan.com.tr



CE



AZZ 42 - CF[®]

**Sabun, Bisküvi,
Gofret ve Kutu Paketleme Makina**
Soap, Biscuits, Waffle & Box Bundling Machine

AZZ 42 - CF[®]

Sabun, Bisküvi, Gofret ve Kutu Paketleme Makina
Soap, Biscuits, Waffle & Box Bundling Machine

Yan yana dizilmiş sabun, bisküvi, gofret veya küçük hacimli kutuların bir arada Multi-pack olarak paketlenmesi için ideal bir makinedir. Opsiyonel olarak elevatör sistemiyle 2 sıra olmak üzere üst üste paketlenme yapılabilir. Besleme işlemi manuel olarak yapılabildiği gibi, ürünün hacmine, şekline ve üretim hattından geliş şekline göre otomatik besleme de yapılabilir. Makinada, OPP boy ayarı ve diğer kalıp değiştirme ayarları, tamamen mekanik olarak kolay ve pratik bir şekilde yapılmaktadır. Makina ile ayrıca istenirse açma bandı aparatı takılarak, paketlenmiş paketlerin kolayca açılması sağlanır ve tarih-seri no yazma cihazıyla da telefonun üstüne tarih ve seri numara atılır.

An ideal machine for over-wrapping & bundling soap bars, biscuits, waffle & small box multi-packs. The machine is feed manually by one or two operators. Also a special design with full automatic feeding system connected directly to the production line is also available depends on the way of production output. AZZ 42 - CF[®] machines have mechanical and easy OPP length adjustment & change-over features. Optionally, elevator system can be provided for 2 rows of stacked packaging. Also tear tape applicator and date printer device are available on this machine upon request.

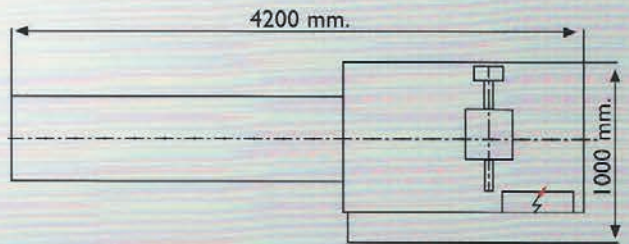
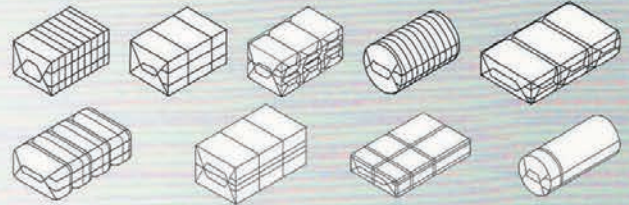

Paketin Boyu Paket Ölçüleri	(A)		(B)	
	Min(mm)	Max (mm)	Min(mm)	Max (mm)
Length - Uzunluk	75	280	140	280
Width - Genişlik	40	110	100	200
Height - Yükseklik	25	80	40	80
OPP Length - Selefyon Boyu	150	420	300	600
Capacity - Güç	20 - 40			
Power - Güç	3.5 KW, 380V - AC 3 Phase			
Weight - Ağırlık	950 kg			

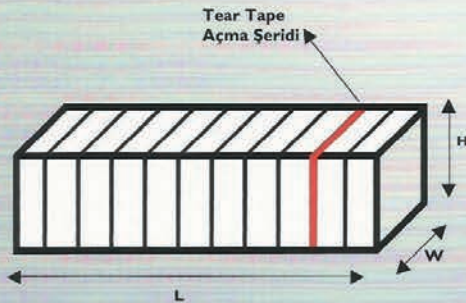

Madenler Durağı Meclis Mahallesi Teraziler Caddesi
PERPİM San. Sit. No:31 A Blok 5 Sancaktepe/İstanbul.TR
Telefon : +90 216 526 05 77 • Fax : +90 216 526 05 76
E-mail : info@unlumakinasan.com.tr

www.unlumakinasan.com.tr



Zarf Tipi Paketlemede
Mükemmellik...
Excellence in Over -
Wrapping

AZZ 42 - CF[®]

Auto Feed (Otomatik Besleme)
Auto Feed (Automatic Feeding)

Tam Otomatik Zarf Tipi Sarmalama Makinaları
Full Automatic Over Wrapping Machinery Production

اوتوماتيكية كاملة في انتاج الات التغليف

www.unlumakinasan.com.tr





AZZ 42 - CF[®]

Auto Feed (Otomatik Besleme)

Auto Feed (Automatic Feeding)



AZZ 42 - CF[®]

Auto Feed (Otomatik Besleme) Auto Feed (Automatic Feeding)

Kare ve dikdörtgen şeklindeki ürünlerin paketlenmesi için tasarlanmış modeldir. Otomatik kutulanmış ürünlerin ya da tek sıra halinde gelen sabunların 2 kat yaparak grup halinde paketlenme yapabilme özelliğine sahiptir. Besleme sistemi seri olarak çalışan bir hatta takılabilir.

Ürün sensörü ürün geldikçe işlem yapar. Eğer ürün yoksa ürünün gelmesini bekler ve işlemine öyle devam eder. Açma bandı ünitesi takılarak ürünlerin kolayca açılması sağlanır ayrıca baskılı ve baskısız ambalaj film ile de çalışabilir.

This model has been designed to wrap square and rectangular shaped products. Products can be wrapped individually, aligned side by side or vertically in groups. The feeding system can be fixed to another working line.

The products sensor will only work as the products arrives. If there is no products, it will wait for the product to arrive and then carry on with its processes. Printed and transparent film material can be used. Tear tape (easy open) equipment can be added to the machine as optional to open the packages easily.

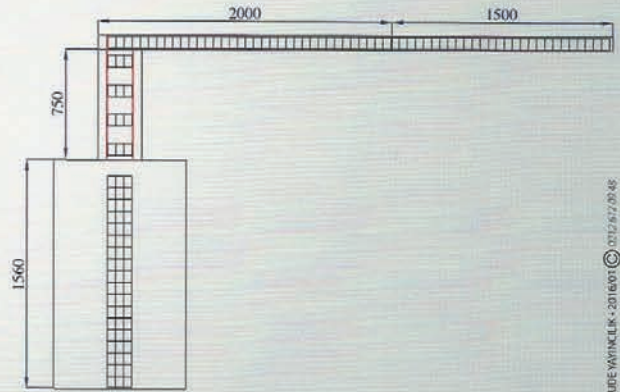

SADE WINDLER - 2016/07 © 012/512/28/48



Packet Size Paket Ölçüleri	(A)		(B)	
	Min(mm)	Max (mm)	Min(mm)	Max (mm)
Length - Uzunluk	50	320	100	320
Width - Genişlik	35	110	75	225
Height - Yükseklik	10	80	40	80
OPP Length - Selefon Boyu	110	420	250	475
Capacity - Güç	20 - 40			
Power - Güç	3.6 KW, 380V - AC 3 Phase			
Weight - Ağırlık	950 kg			

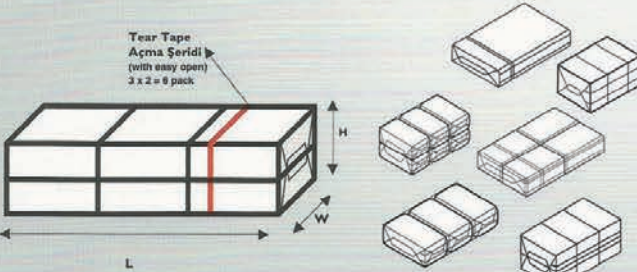

Madenler Durağı Meclis Mahallesi Teraziler Caddesi
PERPİM San. Sit. No:31 A Blok 5 Sancaktepe/İstanbul.TR
Telefon : +90 216 526 05 77 • Fax : +90 216 526 05 76
E-mail : info@unlumakinasan.com.tr

www.unlumakinasan.com.tr



Zarf Tipi Paketlemede
Mükemmellik...
Excellence in Over -
Wrapping



AZZ 42-CF[®]

Auto. Feed. x 2 & Dağıtıcı Hat (Otomatik Besleme)
Auto. Feed. x 2 & Divider Line (Automatic Feeding)

Tam Otomatik Zarf Tipi Sarmalama Makinaları
Full Automatic Over Wrapping Machinery Production
اوتوماتيكية كاملة في انتاج الات التغليف

www.unlumakinasan.com.tr



CE

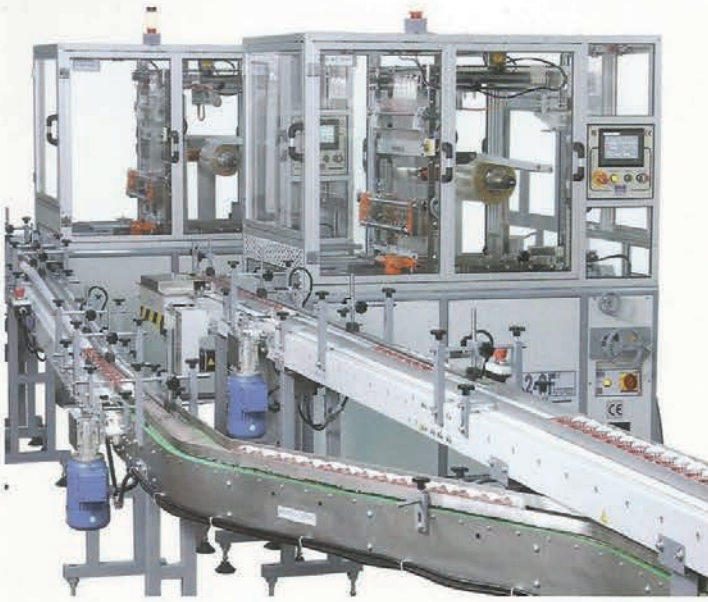

AZZ 42-CF®

Auto. Feed. x 2 & Dağıtıcı Hat (Otomatik Besleme)

Auto. Feed. x 2 & Divider Line
(Automatic Feeding)



AZZ 42-CF®

Auto. Feed. x 2 & Dağıtıcı Hat (Otomatik Besleme) Auto. Feed. x 2 & Divider Line (Automatic Feeding)

Kare ve dikdörtgen şeklindeki ürünlerin paketlenmesi için tasarlanmış modeldir. Otomatik kutulanmış ürünlerin ya da tek sıra halinde gelen sabunların DAĞITICI KONVEYOR SAYESİNDE 2 ayrı makineli hatta senkron halinde dağıtarak grup halinde paketlenme yapabilme özelliğine sahiptir. Besleme sistemi seri olarak çalışan bir hatta takılabilir ve ürün sensörü ürün geldikçe işlem yapar herhangi makine arızasında ürünleri diğer makineye gönderir, eğer iki makinede arıza varsa hattın durmasını engeller boşaltma işlemi yapar. Arızalar giderildikten sonra ürünün gelmesini bekler ve işlemine öyle devam eder. Açma bandı ünitesi takılarak ürünlerin kolayca açılması sağlanır. Ayrıca baskılı ve baskısız ambalaj film ile çalışılabilir.

This model has been designed to wrap square and rectangular shaped products. Products can be wrapped individually, aligned side by side or vertically in groups. The feeding system can be fixed to another working line. The sensor will only work as the products arrives to the line. If there is no products, it will wait for the product to arrive and then continue to it's process. When there is a problem with the machine, the products will be sent to the other machine. If the two achines have problem, it will avoid the machine from stopping and discharging process will start. After the problem has solved, it will wait for products to arrive and then continues to the process. Printed and transparant film material can be used for the machine. Tear tape (easy open) equipment can be added to the machine as optional to open the packages easily.

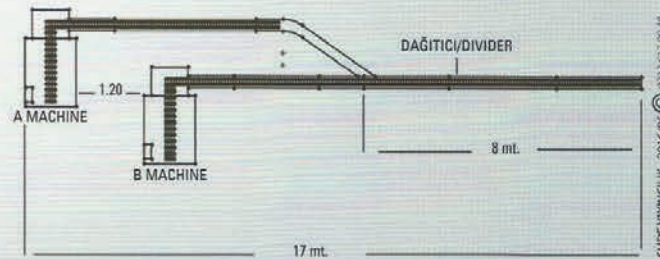

SUDE YAVINCLIK - 2016/005 © 0222 622 89 46



A MAKİNA	(A)		(B)	
Packet Size / Paket Ölçüleri	Minimum	Max (mm)	Minimum	Max (mm)
Length - Uzunluk	50	320	100	320
Width - Genişlik	35	110	75	225
Height - Yükseklik	10	80	40	80
OPP Length - Selefon Boyu	110	420	250	475
Capacity - Güç	20 - 40			
Power - Güç	3.5 kW, 380 V - AC 3 Phase			
Weight - Ağırlık	950 kg			

B MAKİNA	(A)		(B)	
Packet Size / Paket Ölçüleri	Minimum	Max (mm)	Minimum	Max (mm)
Length - Uzunluk	50	320	100	320
Width - Genişlik	35	110	75	225
Height - Yükseklik	10	80	40	80
OPP Length - Selefon Boyu	110	420	250	475
Capacity - Güç	20 - 40			
Power - Güç	3.5 kW, 380 V - AC 3 Phase			
Weight - Ağırlık	950 kg			

Tear Tape
Açma Şeridi
(with easy open)
3 x 2 = 6 pack



DIVIDER/DAĞITICI 4 kW - 380 V - AC 3 PHASE
TOTAL/TOPLAM 11 kW
TOTAL AIRHOSE/TOPLAM HAVA 15 BAR



Madenler Durağı Meclis Mahallesi Teraziler Caddesi
PERPİM San. Sit. No:31 A Blok 5 Sancaktepe/İstanbul.TR
Telefon : +90 216 526 05 77 • Fax : +90 216 526 05 76
E-mail : info@unlumakinasan.com.tr

www.unlumakinasan.com.tr



Zarf Tipi Paketlemede
Mükemmellik...

Excellence in
Over - Wrapping



AZZ 57 - SRV[®]

Servo Sistem Kutu Selefonlama Makinası
Servo System Box Overwrapping Machine

Tam Otomatik Zarf Tipi Sarmalama Makinaları
Full Automatic Over Wrapping Machinery Production

اوتوماتيكية كاملة في انتاج الات التغليف

www.unlumakinasan.com.tr



CE

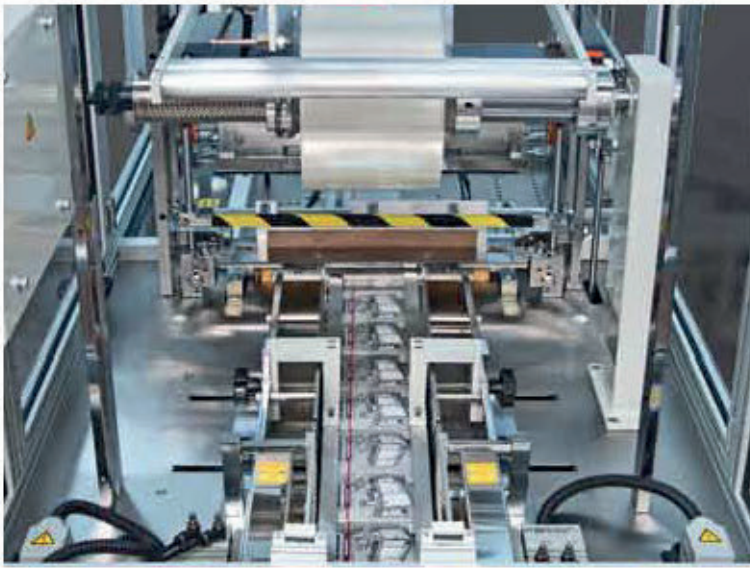

AZZ 57 - SRV[®]

Servo Sistem Kutu Selefonlama Makinası

Servo System Box Overwrapping Machine

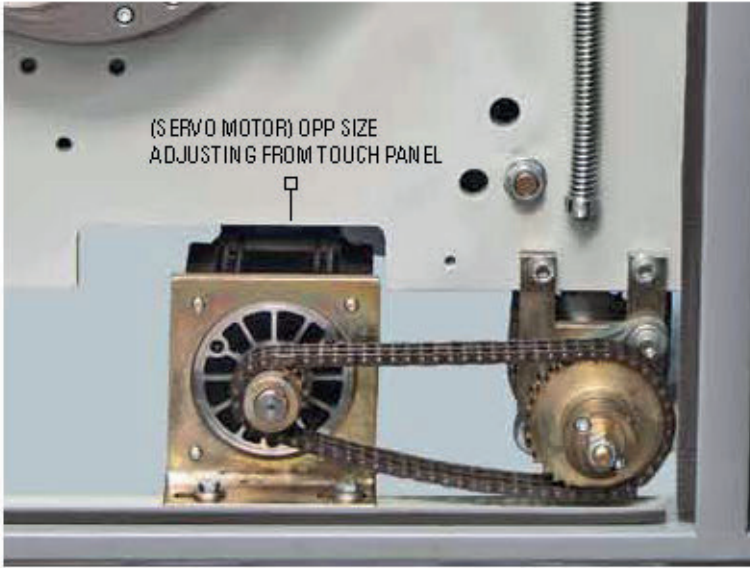

AZZ 57 - SRV[®]

Servo Sistem Kutu Selefonlama Makinası

Servo System Box Overwrapping Machine

Kare ve dikdörtgen şeklindeki büyük hacimli kutuları tek parça veya sıra halinde sarmalamak için ideal ve kullanışlı bir makinedir. Besleme işlemi manuel olarak yapılabilirdiği gibi ürünün üretim hattından geliş şekline göre otomatik besleme de yapılabilir. Makinada OPP boy ayarı Servo Motor PLC ve dokunmatik ekran sistemi sayesinde otomatik olarak yapılır. Diğer kalıp değiştirme ayarları mekanik olarak kolay ve pratik bir şekilde yapılmaktadır. Makina ile ayrıca istenirse açma bandı aparatı takılarak paketlenmiş kutuların kolayca açılması sağlanır ve tarih - seri no yazma cihazıyla da telefonun üstüne tarih ve seri numara atılır.

An ideal machine for over-wrapping big size boxes as single box or multi-pack wrapping. The machine can be fed either manually or automatically from a production line. AZZ 57-SRV[®] machines have full automatic OPP Length adjustment features via servo motor PLC & 7.3" touch screen system. This machine is normally used by for big size boxes or for clients who have many different boxes. Machine is very user friendly with easy & short change over from box to another. Tear tape applicator and date printer device are available on this machine upon request.

Paket Şeşi Paket Ölçüleri	(A)		(B)	
	Min(mm)	Max(mm)	Min(mm)	Max(mm)
Length - Uzunluk	50	320	100	320
Width - Genişlik	25	150	100	225
Height - Yükseklik	20	100	20	50
OPP Length - Selefon Boyu	130	450	250	600
Capacity - Güç	15 - 35			
Power - Güç	5 KW, 380V - AC 3 Phase			
Weight - Ağırlık	950 kg			

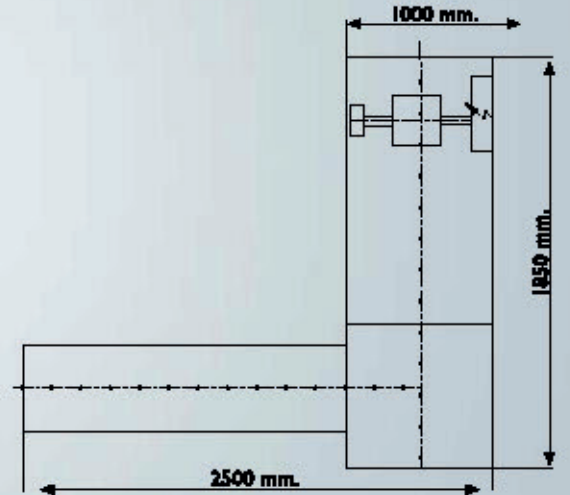
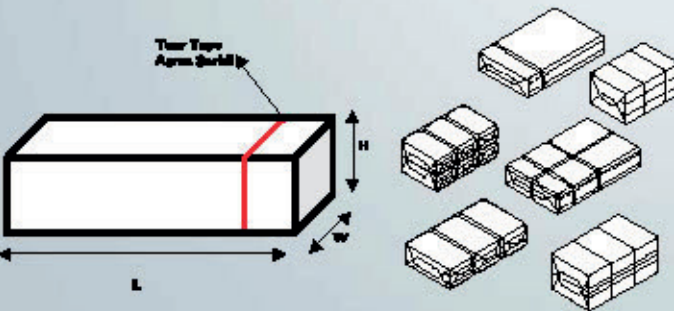

ŞİŞE LİNE: 2016/02 © ÜNLÜ 412 00/08



Madenler Durağı Meclis Mahallesi Teraziler Caddesi
PERPİM San. Sit. No:31 A Blok 5 Sancaktepe/İstanbul.TR
Telefon : +90 216 526 05 77 • Fax : +90 216 526 05 76
E-mail : info@unlumakinasan.com.tr

www.unlumakinasan.com.tr



Zarf Tipi Paketlemede
Mükemmellik...
Excellence in
Over - Wrapping



AZZ M - 4257®

Servo Kontrollü Yarı Otomatik Zarf Tipi Ambalaj Makinası
Servo Controlled Semi-Automatic Envelope Type Packing Machine

Tam Otomatik Zarf Tipi Sarmalama Makinaları
Full Automatic Over Wrapping Machinery Production

اوتوماتيكية كاملة في انتاج الات التغليف

www.unlumakinasan.com.tr



CE



AZZ M - 4257[®]

Servo Kontrollü Yarı Otomatik Zarf Tipi Ambalaj Makinası

Servo Controlled Semi-Automatic Envelope Type Packing Machine

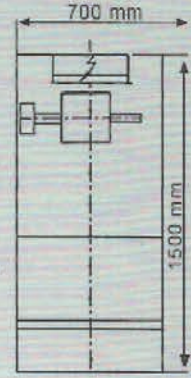
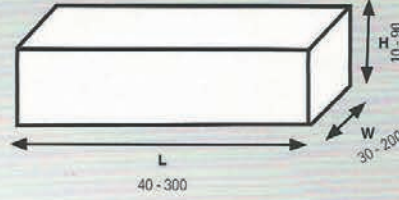
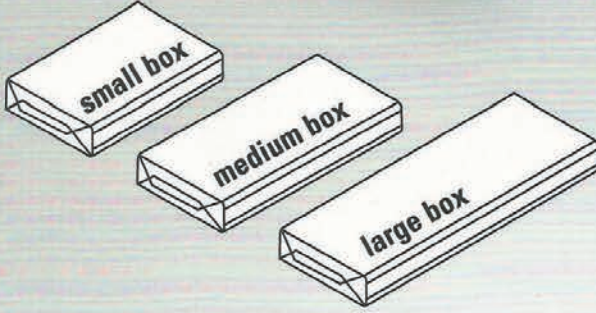

Able to pack -overwrap the products within dimensions shown on right side chart.

AZZ M - 4257[®]

Servo Kontrollü Yarı Otomatik Makina Servo Controlled Semi-Automatic Machine

Kare ve dikdörtgen şeklindeki küçük, orta ve büyük hacimli kutuların tek parça veya sıra halinde manuel olarak sarmalamak için ideal, pratik ve çok kullanışlı bir makinedir. Herhangi bir anahtar kullanmadan makinenin servo kontrollü dokunmatik panelinden gerekli parametreleri girdikten sonra kalıp değişimi hızlı bir şekilde yapılır.

Square and rectangular shaped small, medium and large box wrapped as a single piece or as manual in case you're looking for, practical and very useful machine. Without using any key servo-controlled from the touch panel of the machine enter the required parameters after the mold change is made quickly.

Packet Size Paket Ölçüleri	(A)	
	Min(mm)	Max (mm)
Length - Uzunluk	40	300
Width - Genişlik	30	200
Height - Yükseklik	10	90
Capacity - Kapasite	7 - 20	
Power - Güç	1.2 KW, 220V50hz - 72a	
Weight - Ağırlık	350 kg	

SLIDE MAKİNASI 2016/03 © 012.16.179.48



Madenler Durağı Meclis Mahallesi Teraziler Caddesi
PERPİM San. Sit. No:31 A Blok 5 Sancaktepe/İstanbul.TR
Telefon : +90 216 526 05 77 • Fax : +90 216 526 05 76
E-mail : info@unlumakinasan.com.tr

www.unlumakinasan.com.tr



1983'den bugüne...



- AZZ 42-BF |
- AZZ 57-SRV |
- AZZ M-4257 |
- AZZ 42-CF |
- AZZ 42-CF AUTO FEED |
- AZZ 42-CF AUTO FEED LINE |
- AZZ 42-CF & STACKER |
- AZZ RTR-20 |
- AZZ-PPR |
- AZZ FLW-S1 |